



# THE COMPACT SOLUTION FOR BRILLIANT PROJECTIONS.

Explore a myriad of possibilities with Epson's EB-L500/L600 series. These projectors are light, compact and project vibrant images of up to 6000 lumens powered by the newly developed optical laser diode package. With features including center-lens placement, flexible 360° installation and wider lens shift, installation has never been easier. Enjoy a wide range of connectivity options such as HDBaseT<sup>^</sup>, and experience seamless usability with screen mirroring function\* that allows you to project from smart devices. Designed with details, these projectors help you deliver great presentations with maximum convenience.



**IT'S IN THE DETAILS.**  
 3LCD technology that delivers quality projected images and reliable performance.

\* Applicable for EB-L610U only.  
<sup>^</sup> Except EB-L500W.



# Incredible Laser Projection

## Revolutionary Light Source

The newly designed laser light source and advanced electrostatic filter deliver up to 20,000 hours of maintenance-free use. Inorganic LCD panels and an inorganic phosphor wheel, coupled with a dustproof design, offer up to 20,000 hours of maintenance free usage, even with 24/7 usage. What's more, the laser light source is highly reliable, eliminating the worry of the light burning out during important presentations.



LD (laser diode) package

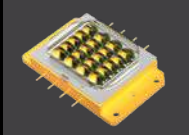

Inorganic LCD panels



Inorganic phosphor wheel





Electrostatic filter

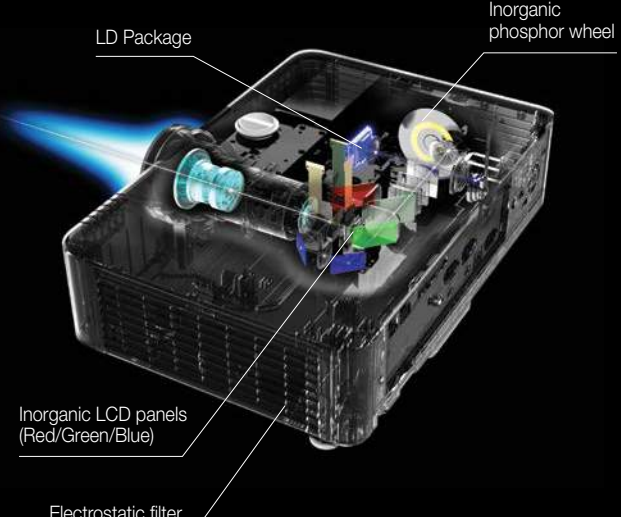

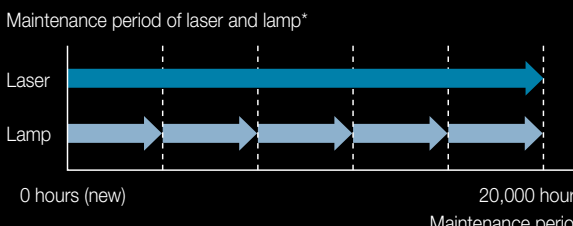

Maintenance period of laser and lamp\*

	
Laser	
Lamp	
0 hours (new)	20,000 hours
	Maintenance period

\* Approximate time until brightness decreases 50% from first usage. Time varies depending on usage conditions and environments.

## Inorganic LCD Panels and Phosphor Wheel for Outstanding Reliability

Made of inorganic material, Epson's newly developed phosphor wheel offers superior light and heat resistance to deliver excellent reliability. By combining this with our inorganic LCD panels, we create laser projectors that project bright, vibrant images for extremely long periods.

### Organic vs. Inorganic

	Inorganic (Glass, iron, aluminum, etc.)	Organic (Paper, wood, plastic, etc.)
<b>Light-resistance</b>	<b>YES</b> 	<b>NO</b> 
<b>Heat-resistance</b>	<b>YES</b> 	<b>NO</b> 

Unlike organic substances, inorganic substances do not contain carbon.



### Incredible Beyond Full HD Resolution\*

Enjoy dynamic viewing experience on larger screen with the incredible WUXGA resolution\*. Deliver superb high-resolution image displays from PCs, Blu-ray and other graphic intensive media. Immerse your audience in vivid razor sharp images, even on larger screens.

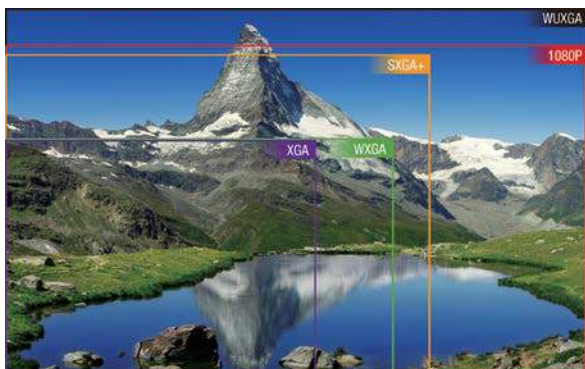

\* Available on EB-L510U/L610U

### High Contrast Ratio

Add brilliance to your presentations. Boasting stunning brightness of up to 6,000 lumens and a high contrast ratio of 2,500,000:1, these projectors enable you to project beautiful, well-defined images wherever you are, regardless of ambient light.



### Fine-tuning Brightness

This series provides precise brightness adjustment in increments of 1%. This combined with the Constant Brightness mode maintains brightness at a given value to match the venue or subject to deliver astonishing picture quality.

#### Custom brightness

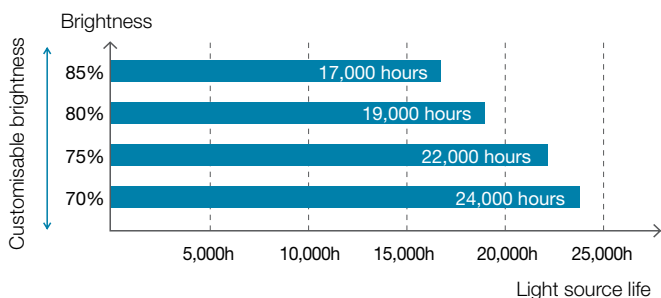

EB-L510U / EB-L500W

#### Custom brightness

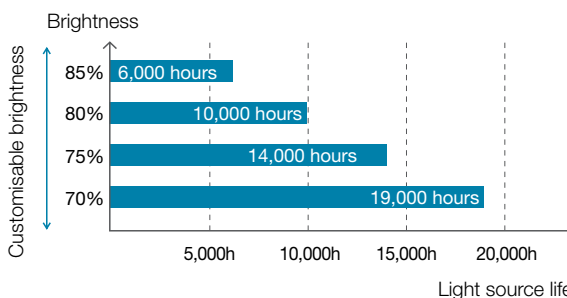

EB-L610U / EB-L610W

# Ease-of-Projection



## Centre-lens Placement

With the projector lens placed centrally in the unit, installation is a breeze as there is no need to calculate the distance between the lens and screen centre. The centre-lens placement also offers longer throw ratio and wider lens shift for greater projection flexibility.

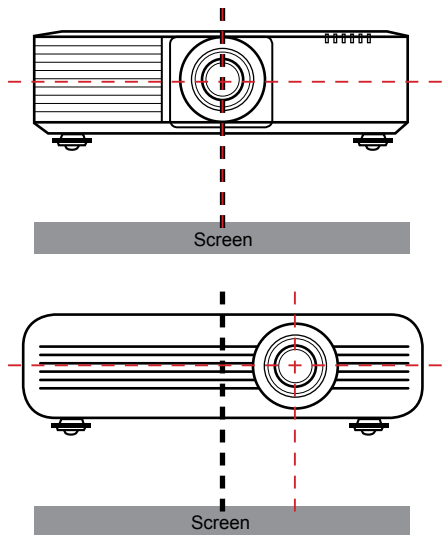

## Bright and Compact

The newly developed optical LD (laser diode) package is approximately 2.5x brighter than conventional laser banks. Small and compact, this new optical engine also helps reduce the projector's size, making the EB-L500/L600 series an ideal fit for a wide range of environments, including modern offices and luxury interiors.

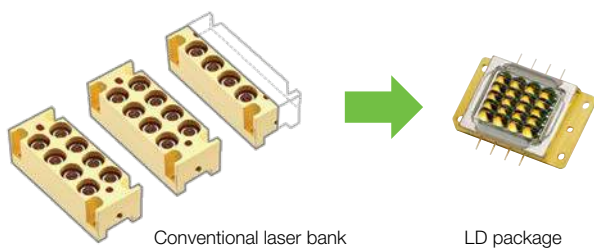

## Wide-range Zoom and Lens Shift

With manual zoom and lens shift covering a wide range of angles, you enjoy a greater deal of flexibility when installing the projector. What's more, wider lens shift and throw ratio mean sharp, vibrant presentations from both short- and long-throw distances.

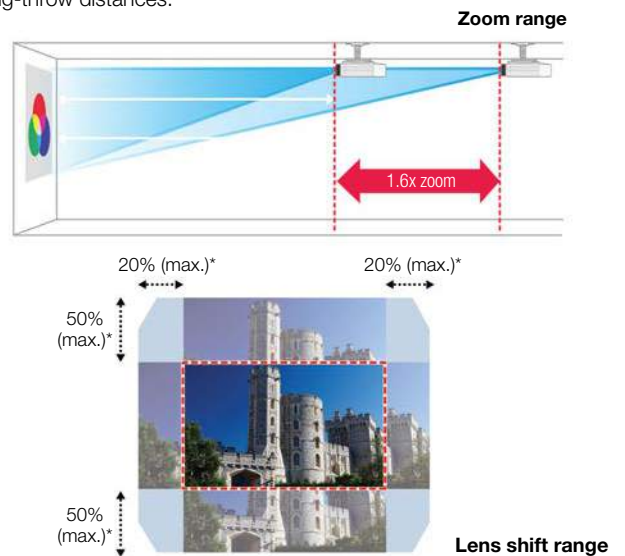

\*  $\pm 50\%$  vertically,  $\pm 20\%$  horizontally for EB-L610U/L510U/L610W  
 EB-L500W does not have Lens Shift

## Flexible 360° Installation

The EB-L500/L600 series can be rotated 360° in any direction – horizontally, vertically and rotationally – without any loss in image brightness. This makes it ideal for a wide range of applications, such as projecting onto ceilings and floors.





## Wide Range of Connectivity

This series is compatible with a wide range of external devices, and additional ports now include HDMI and HDBaseT\*. Ideal for large venues, HDBaseT can transmit Full HD video, audio and control at low cost through cat 5e/6 cables or higher, up to 100 metres.

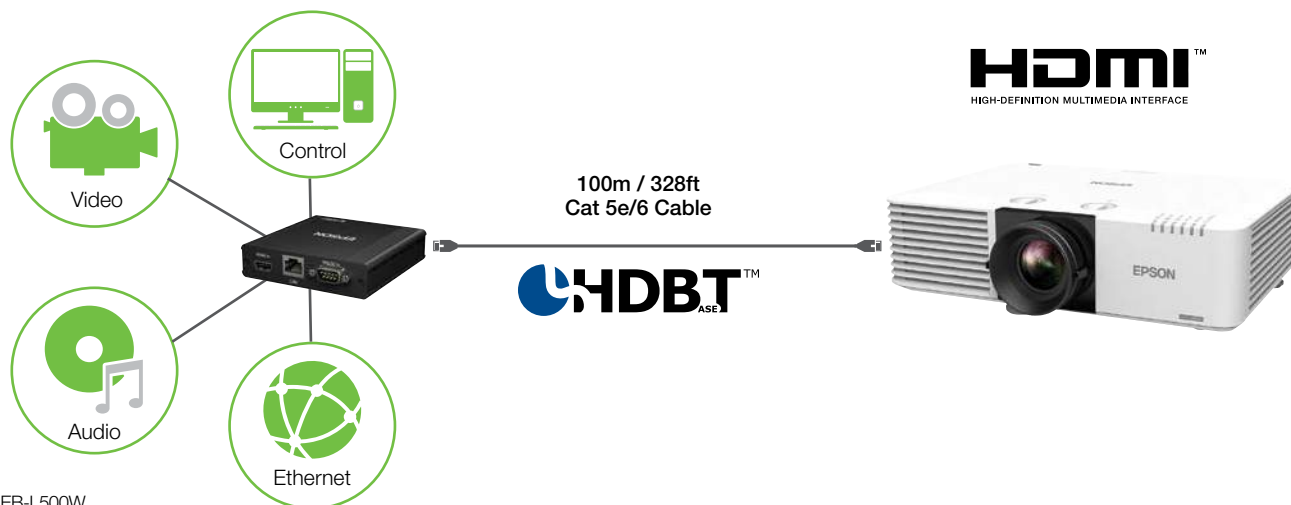

\* Except for EB-L500W

## Quick Corner

With the quick corner feature, you can use the keystone correction and lens shift function simultaneously for maximum projection without having to worry about unintentionally changing the aspect ratio.

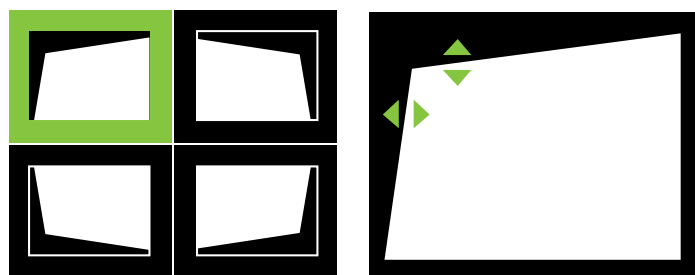

Select where to correct

Use arrow keys to correct

## Arc Correction

Quickly and easily correct any vertical or horizontal distortion of the projected image on large screens.

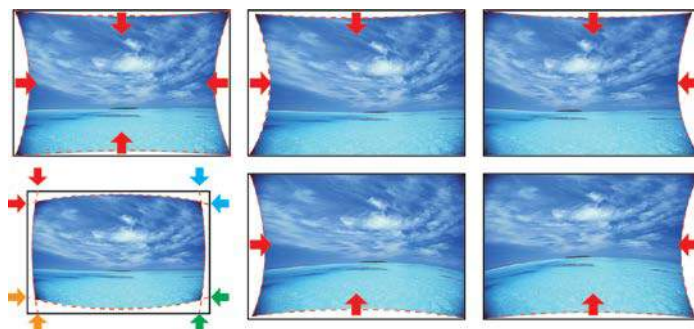

# Seamless Connectivity and Usability

## Split Screen

Display images from two different sources side by side on the same screen for a more effective presentation. In video conferences, for example, images of presentation materials and remote participants can be shown simultaneously.



## Quick Start

Use the Quick Startup mode to start projecting in approximately half the time it takes in default mode.

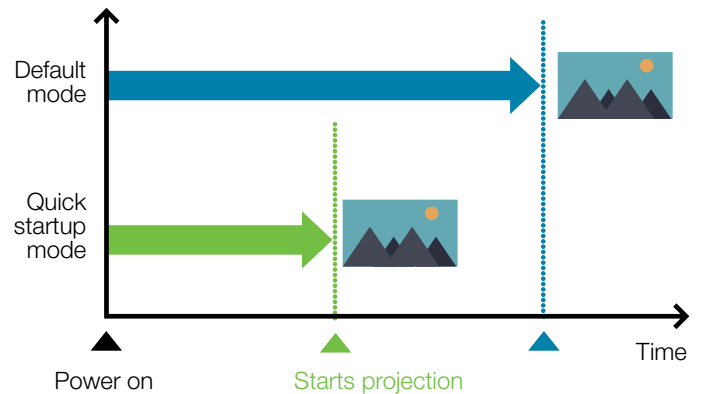

## Convenient Wireless Mirroring Projection\*\*

Project contents wirelessly from compatible smart devices and laptops without any software installation with the Miracast function. The technology enables easy wireless transmission of Full HD video and sound from PCs and smart devices, eliminating the hassle of a physical connection and eradicating issues with setting up. With support for screen mirroring\*, projecting your tablet and laptop screens has never been easier.



\* If the Miracast function is activated, other network features will be disabled.  
\*\* Applicable for EB-L610U only.



## Epson Projector Content Manager

The Epson Content Manager gives you a whole range of control, including scheduling and editing playlists, converting movie formats, managing USB data – all without the need for external 3rd party software. What's more, you can even create content, save your work on a USB and project it wherever and whenever you need. Perfect for the digital signage market!

1. Creating contents with Epson Projector Content Manager



2. Connecting created contents to USB



3. Setting "contents play on" on OSD menu

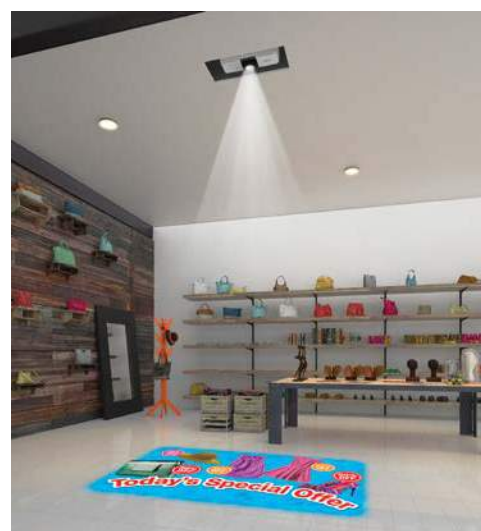

## Wireless Transmission

Enjoy enhanced connectivity and flexibility with in-built Wi-Fi\* connectivity. Easily share and transmit images and files from your PC / smart devices using the "Epson iProjection" application for smooth and smart projections.



\* Applicable for EB-L610U only. For other models, wireless LAN adaptor ELPAP10 is required.

## Epson iProjection

The iProjection application enables a wireless connection for projecting images and files from your smart devices. The “QR Code Reader” function makes this wireless connection even easier by simply reading the QR code that is projected on the screen from your smart devices.

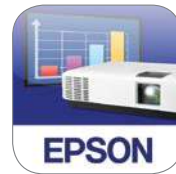

\* In iProjection, projector profile search, multi-screen display, distribution function, audio transfer, movie file transfer, interrupt connection disabling and encryption data transfer capabilities are not supported.

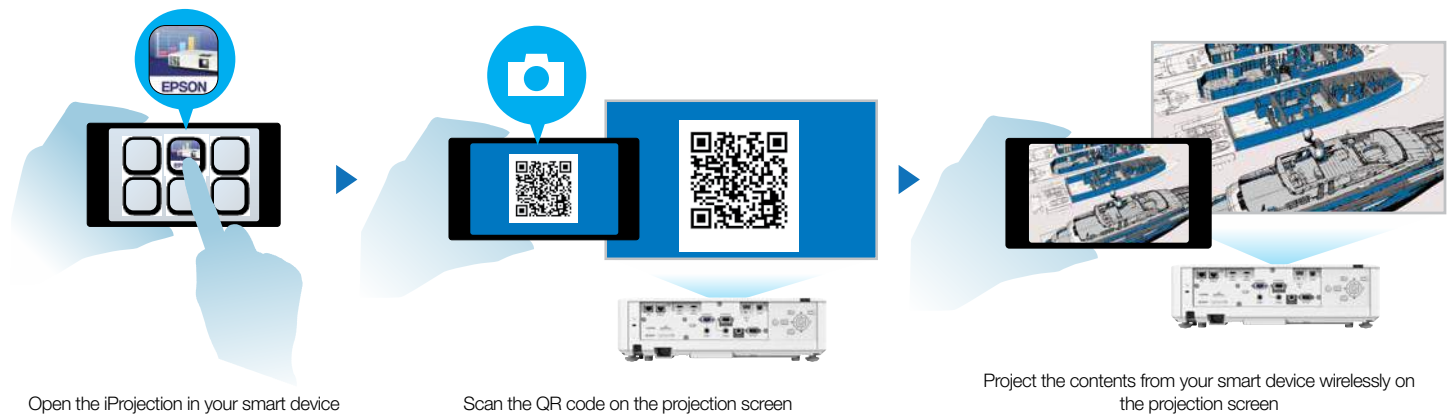

## Epson Projector Management

With Epson’s network monitoring and control software, you can see from a single PC which projectors are available and whether they are running efficiently – even across the biggest network. You can configure your projectors and access their serial numbers remotely, as well as receive instant email alerts for pre-defined critical indicators such as non-functioning devices or overheating laser diode.

Now you can send messages or announcements simultaneously to any number of projectors on a network. This makes the EB-L500/L600 projector series very useful for immediate communication needs or even emergencies.

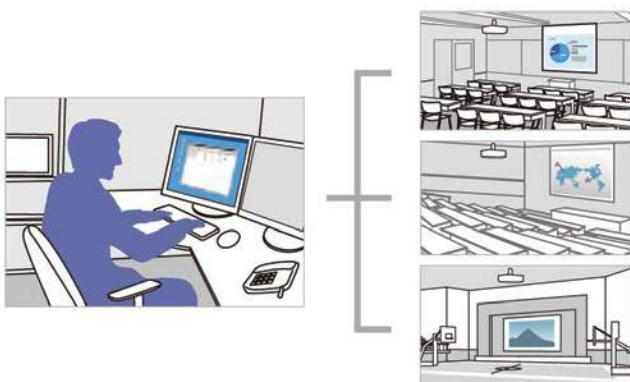

## Web Control

By connecting your projector to a network, you can adjust your projector installation entries from a PC or smart device.



## Transfer OSD Information

Reduce installation and setup time when using multiple projectors by transferring OSD settings — such as brightness and colour settings as well as user logos — to multiple machines via USB or over a network.



# SEE VIBRANT, REALISTIC COLOURS WITH HIGH COLOUR BRIGHTNESS.



\*Leading Epson business and education projectors vs. leading 1-chip DLP projectors, selected according to NPD data as of July 2018. Based on U.S. research conducted by Radix Research.

See colours like never before. Epson 3LCD projectors deliver brilliant colours that match its white brightness to give you balanced, realistic, and vibrant images. It's no wonder Epson projectors are the people's preferred choice.



## Up to 3X Wider Colour Gamut

Colour gamut refers to the range of colours that can be reproduced by a display device – the wider the gamut, the more realistic it is. Epson 3LCD projectors project three times wider gamut that matches closely to the original standard of a display device (sRGB), as compared to 1-chip projectors.

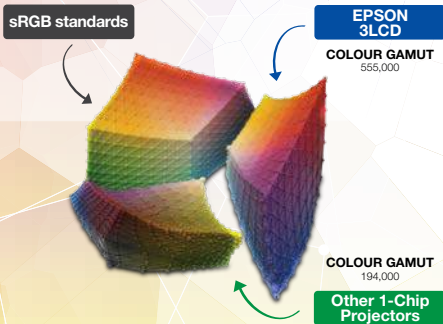

Comparing the yellow corners among the three gamuts, 1-chip projectors have a distinctly darker and smaller set of colours which are not as vibrant as Epson 3LCD projectors.



## Up to 3X Brighter Colours

Epson 3LCD projectors deliver up to three times the colour brightness, effortlessly creating the same colour and white brightness, resulting in faithful images with superior colour balance.

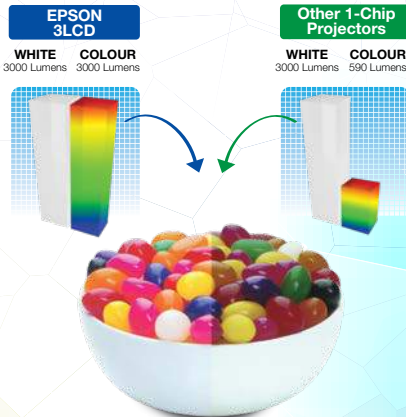

## No Rainbow Effect

With 1-chip projectors, the spinning motion of the sequential colour wheels tend to cause colours to break out into distinct red, green and blue. Called the rainbow effect, this may cause users to suffer headaches with prolonged viewing. Epson projectors do not give out this effect, giving users a comfortable experience.



# BIGGER PROJECTION. BRIGHTER FUTURE.

“More than half of the students are unable to read certain contents displayed on a 70" flat panel display.”

- Radius Research.



Flat Panel Display

Epson Projector

58% of students from US, 61% from UK, and 57% from Singapore are unable to read contents on a 70-inch flat panel display\*. This is why we've built projectors that depict larger and more immersive pictures, so that you can fully engage your audience and maximise every learning experience with exquisite detail and vibrancy. By not downsizing classroom displays to flat panels—you ensure the brightest minds of our future are not hindered by contents displayed too small and unreadable. Experience the real practical difference today.

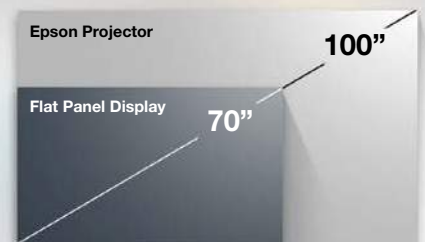

 EpsonSEA
  @EpsonSEA
  @EpsonSEA
  EpsonSoutheastAsia
  Epson Southeast Asia

To find out more, visit [www.epson.com.sg/displaysizematters](http://www.epson.com.sg/displaysizematters)

\*Based on research conducted by Radius Research in US, UK and Singapore. The research was done using a 70-inch class 4k resolution flat panel in a 22' x 27' / 22' x 26' / 22' x 30' classroom-style arrangement respectively. When asked to copy down six short items of information from slides displayed, 58% of students from US, 61% from UK, and 57% from Singapore, aged 12-22, copied at least one item incorrectly.



**CAD DRAWING**  
**EB-L500W**

**Top View**

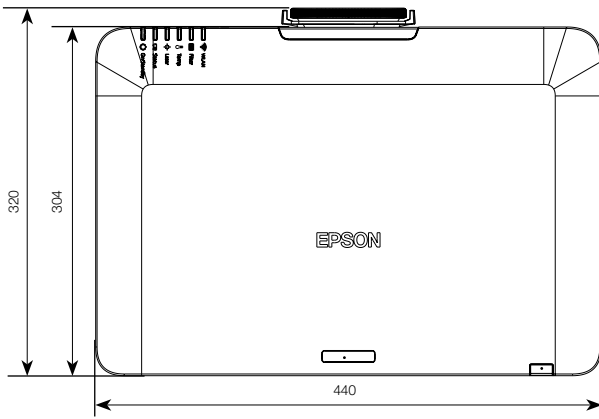

**Bottom View**

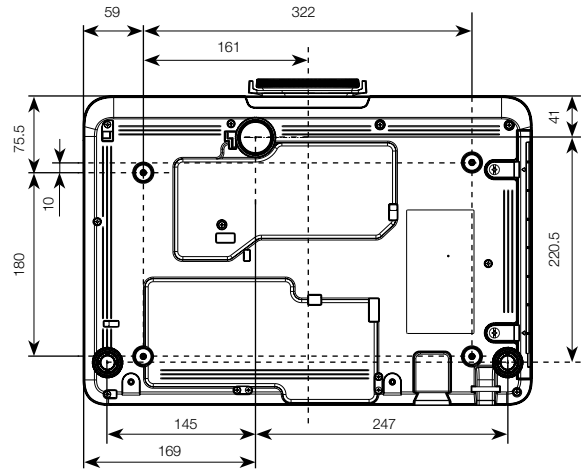

**Front View**

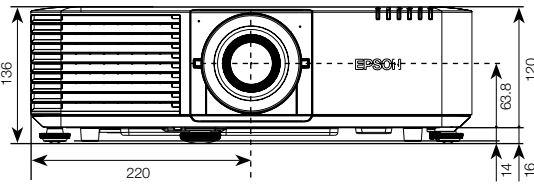

**Side View**

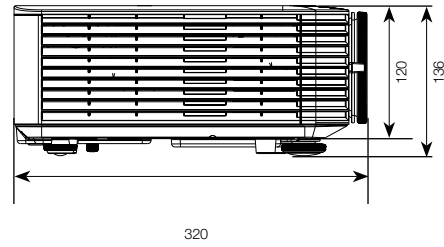

**CAD DRAWING**  
**EB-L610U/L510U/L610W**

**Top View**

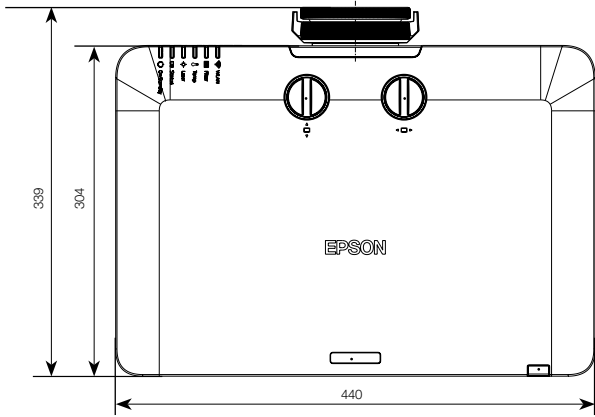

**Top View with Cable Cover**

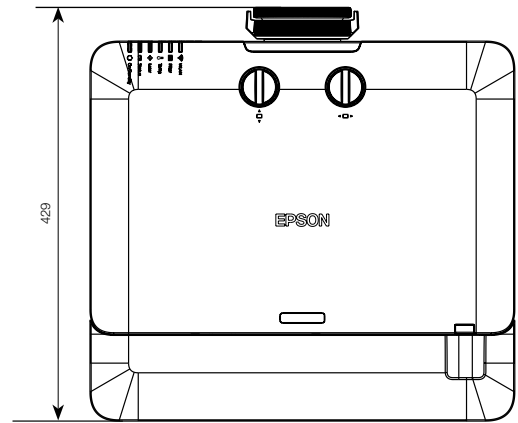

**Bottom View**

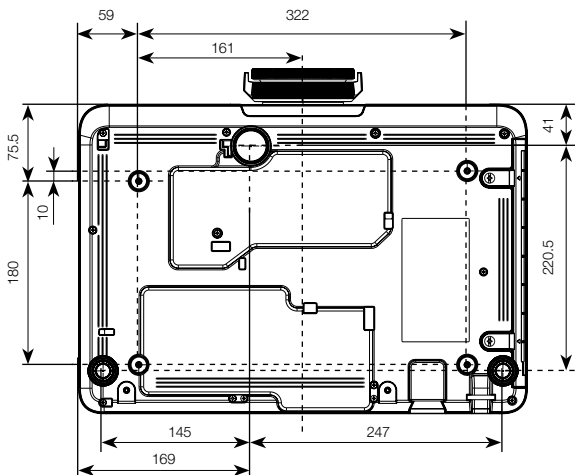

**Front View**

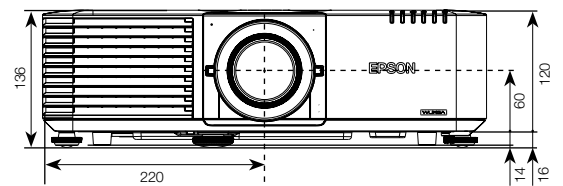

**Side View**

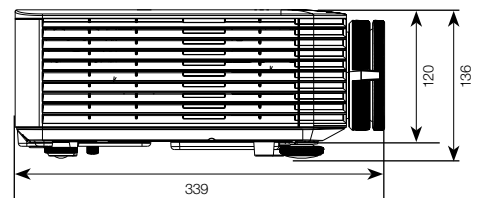

# SPECIFICATIONS

## EB-L610U/L510U/L610W/L500W

MODEL NUMBER	EB-L610U	EB-L510U	EB-L610W	EB-L500W
<b>Projection Technology</b>	RGB liquid crystal shutter projection system			
<b>Specifications of Main Parts</b>				
LCD	Size	0.67" (D10 C <sup>2</sup> fine)		0.59" (D8 C <sup>2</sup> fine)
	Native Resolution	WUXGA (1920 x 1200)		WXGA (1280 x 800)
Lightsource	Type	Laser Diode		
	Life (Normal / Quiet / Extended)	20,000 / 20,000 / 30,000 hours		
Projection Lens	Type	Optical Zoom (Manual) / Focus (Manual)		
	F-Number	1.5 - 1.7		1.5 - 2.0
	Focal Length	20.0 - 31.8 mm		18.2 - 29.2 mm
	Zoom Ratio	1-1.6		
	Throw Ratio	1.35 - 2.20 (Wide to Tele)		1.38 - 2.24 (Wide to Tele)
	Lens Shift Type	Manual		
	Vertical (Up/Down)	-50%		N/A
Horizontal (Left/Right)	-20%		N/A	
<b>Screen Size (Projected Distance)</b>				
Zoom: Wide	50" - 500" [1.44 - 14.76 m]		29" - 280" [0.85 - 8.45 m]	
Zoom: Tele	50" - 500" [2.35 - 23.84 m]		29" - 280" [1.40 - 13.71 m]	
<b>Brightness<sup>1</sup></b>				
White Light Output (Normal / Extended)	6,000lm / 4,200lm	5,000lm / 3,500lm	6,000lm / 4,200lm	5,000lm / 3,500lm
Colour Light Output	6,000lm	5,000lm	6,000lm	5,000lm
<b>Contrast Ratio</b>				
Over 2,500,000:1				
<b>Internal Speaker(s)</b>				
Sound Output	10W Monaural			
<b>Geometric Correction</b>				
Vertical / Horizontal Keystone	±30° / ±30°			
Auto Keystone	Yes			
Quick Corner	Yes			
Arc Correction	Yes			
<b>Connectivity</b>				
Analog Input	D-Sub 15Pin	2		
	HDMI	2		
	HDbaseT	RJ45 x 1		N/A
Output Terminal	D-Sub 15Pin 1 Shared with Computer 2			
Audio Input	Stereo Mini Jack 2			
Audio Output	Stereo Mini Jack 1			
Others	USB Type A 1 (for USB Memory, USB Document Camera, Firmware Update, Contents Playback, Copy OSD Settings)		1 (for USB Memory, USB Document Camera, Wireless LAN, Firmware Update, Contents Playback, Copy OSD Settings)	
	USB Type B 1 (for Mouse, K/B, Control, Firmware Update)			
Control I/O	RS-232C D-Sub 9pin x 1			
Network	Wired Lan RJ45 x 1			
	Wireless Built in		ELPAP10 Optional	
<b>Wireless Specification (Screen Mirroring)</b>				
Supported Speed	IEEE 802.11g (2.4GHz): 54Mbps <sup>2</sup> IEEE 802.11n (2.4GHz): 130 Mbps <sup>2</sup> IEEE 802.11a (5GHz): 54 Mbps <sup>2</sup> IEEE 802.11n (5GHz): 270 Mbps <sup>2</sup> IEEE 802.11ac (5GHz): 780 Mbps <sup>2</sup>		N/A	
Supported Security Type	WPA2-PSK (AES)		N/A	
Supported Connection Mode	Wi-Fi Direct		N/A	
<b>Wireless Specification (Wireless LAN)</b>				
Supported Speed	IEEE 802.11b (2.4GHz): 11 Mbps IEEE 802.11g (2.4GHz): 54 Mbps IEEE 802.11n (2.4GHz): 65 Mbps IEEE 802.11a (5GHz): 54 Mbps IEEE 802.11n (5GHz): 65 Mbps		IEEE 802.11b (2.4GHz): 11 Mbps <sup>3</sup> IEEE 802.11g (2.4GHz): 54 Mbps <sup>3</sup> IEEE 802.11n (2.4GHz): 130 Mbps <sup>3</sup>	
Supported Security Type	Quick Mode: Open, WPA2-PSK Advanced Mode: Open, WPA/WPA2-PSK, WPA/WPA2-EAP Supported EAP Type: PEAP, PEAP-TLS, EAP-TLS, EAP-Fast, LEAP Infrastructure, Access Point			
Supported Connection Mode	Infrastructure, Access Point			
<b>Operating Temperature</b>				
	0 - 45 °C <32 - 113 °F> (Below 1,500m / 4,921ft) 0 - 40 °C <32 - 104 °F> [Above 1,500m / 4,921ft - 3,048m / 10,000ft (with high altitude mode)] (20% - 80% humidity, no condensation)			
<b>Operating Altitude</b>				
	0 - 3,048 m <0 - 10,000 ft> (over 1,500m / 4,921ft : with high altitude mode)			
<b>Direct Power On / Off</b>				
	Yes			
<b>Start-Up Period</b>				
	Less than 7 seconds, Warm-up Period: 30 seconds Quick Start: Less than 5 seconds (display)			
<b>Cool Down Period</b>				
	Instant Off			
<b>Air Filter</b>				
Type	High Efficiency Filter			
Maintenance Cycle (Normal / Quiet / Extended)	20,000 / 20,000 / 30,000 hours <sup>4</sup>			
<b>Power Supply Voltage</b>				
	100 - 240 V AC ±10%, 50/60 Hz			
<b>Power Consumption (220 - 240V)</b>				
Laser Diode (Normal / Quiet / Extended)	353W / 265W / 265W		322W / 244W / 244W	353W / 265W / 265W  322W / 244W / 244W
Standby (Network / Energy Saving)	2.0W / 0.3W			
<b>Dimension Excluding Feet (D X W X H)</b>				
	304 x 440 x 120 mm			
<b>Weight</b>				
	Approx. 8.5kg		Approx. 7.4kg	
<b>Fan Noise (Normal / Eco)</b>				
	38dB / 27dB		37dB / 25dB	38dB / 27dB  37dB / 25dB

### Supplied Accessories

Power Cable: 3m only  
Remote Control with 2 x AA Battery  
Cable Cover (Except EB-L500W)  
Quick Start Guide Printed  
CD (PDF)  
VGA Cable: 1.8m  
Wireless LAN Unit Cover (Except EB-L610U)  
Zoom Ring Lock (Only for EB-L500W)

### Optional Accessories

Air Filter: ELPAP56  
Wireless LAN: ELPAP10 (All models except EB-L610U as it is built-in)  
Ceiling Mount: ELPMB22

EB-L610U / EB-L510U / EB-L610W



EB-L500W



©2018 Epson Singapore Pte Ltd. All Rights Reserved. Reproduction in part or in whole, without the written permission from Epson, is strictly prohibited.

EPSON and EXCEED YOUR VISION are registered trademarks of Seiko Epson Corporation.

All other product names and other company names used herein are for identification purposes only and are the trademarks or registered trademarks of their respective owners.

Epson disclaims any and all rights in those marks. Projected images shown herein are simulations. The actual product design and contents may vary. Specifications are subject to change without notice and may vary between countries. Please check with local Epson offices for more information.

Apple, iPad and iPhone are trademarks of Apple Inc., registered in the U.S. and other countries. App Store is a service mark of Apple Inc.

Android is a trademark of Google Inc.

Information correct as at December 2018

<sup>1</sup> Colour brightness (colour light output) and white brightness (white light output) will vary depending on usage conditions. Colour light output measured in accordance with IDMS 15:4; white light output measured in accordance with ISO 21118.

<sup>2</sup> These modes and actual data throughputs depend on supported wireless mode of source devices and/or environmental conditions.

<sup>3</sup> Maximum speed and range is achievable when used with same enhanced mode technology. Actual data rates, features and performance may vary depending on your computer system, the environment and other factors.

<sup>4</sup> When used in the general office environment (the amount of floating dust: 0.04 - 0.2 mg/m<sup>3</sup>). Based on the Epson's in-house test results.